

Top View

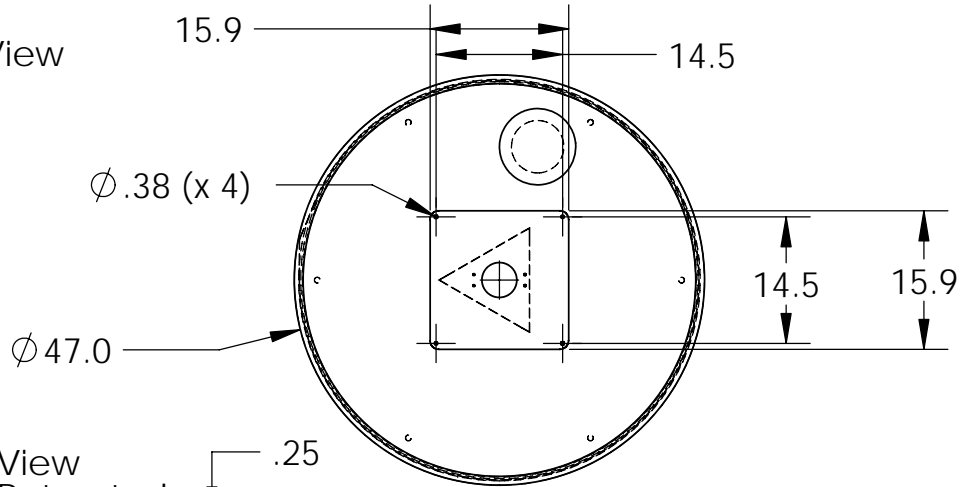

Side View Fully Retracted

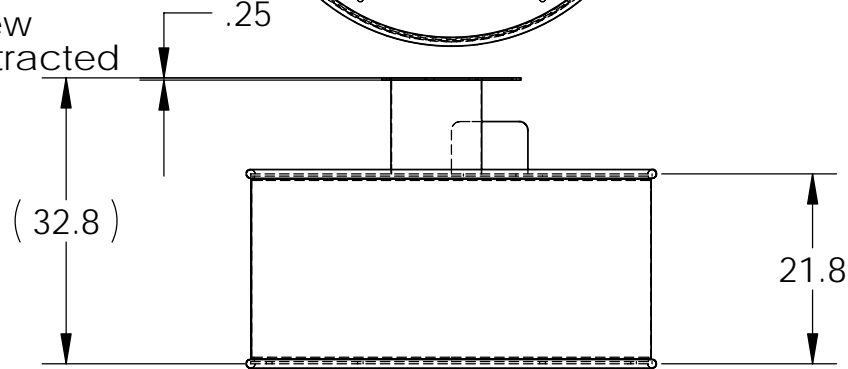

Bottom View

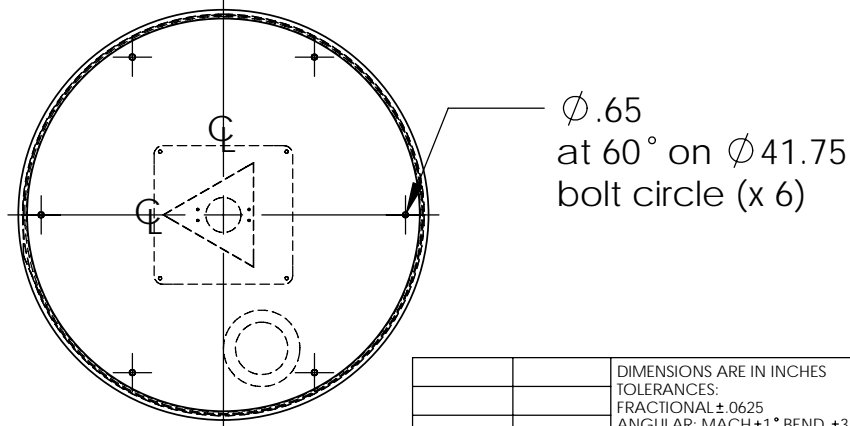

REVISIONS				
ZONE	REV.	DESCRIPTION	DATE	APPROVED
	A			
	B			
	C			
	D			
	E			
	F			

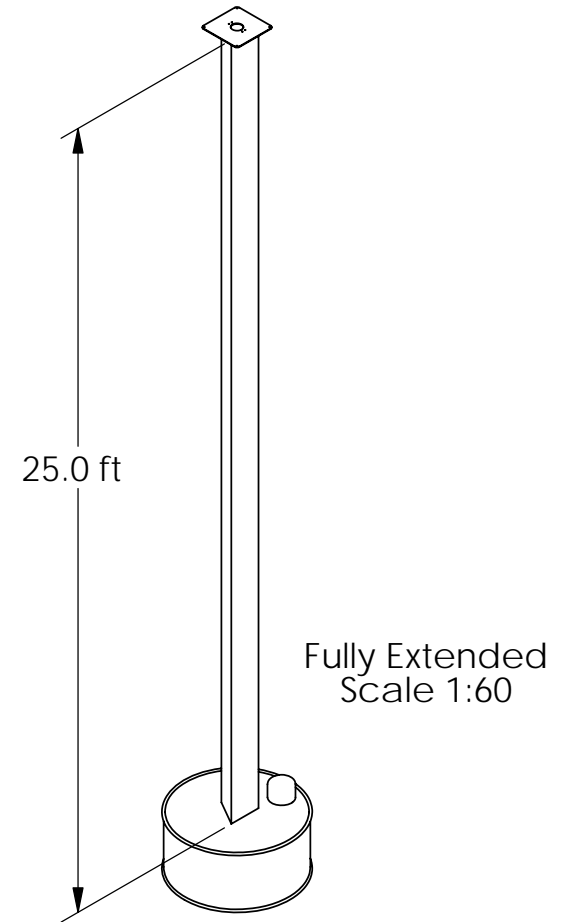

PROPRIETARY AND CONFIDENTIAL
 THE INFORMATION CONTAINED IN THIS DRAWING IS THE SOLE PROPERTY OF ACTUA SYSTEMS INC. ANY REPRODUCTION IN PART OR AS A WHOLE WITHOUT THE WRITTEN PERMISSION OF ACTUA SYSTEMS INC. IS PROHIBITED.

		DIMENSIONS ARE IN INCHES TOLERANCES: FRACTIONAL ±.0625 ANGULAR: MACH ±1° BEND ±3° ONE PLACE DECIMAL ±.02 TWO PLACE DECIMAL ±.015 THREE PLACE DECIMAL ±.005 REF DIM: OPEN TOLERANCE		NAME	DATE	ACTUA
		MATERIAL		DDP	07/25/08	
		FINISH		CHECKED		PositionIt Model 12 Standard
		NEXT ASSY USED ON		ENG APPR.		
APPLICATION		DO NOT SCALE DRAWING		MFG APPR.		FILE NAME model 12 top level assembly SIZE DWG. NO. A REV.
				Q.A.		
				COMMENTS: Break All Edges Ref Dims in Parentheses		SCALE:1:22
				WEIGHT: 625 lbs (base unit)		SHEET 2 OF 4